

# WINDLIGHT *Led profiles*



**FBS Profilati srl, fondata nel 1999  
dalla seconda generazione  
imprenditoriale della nostra famiglia,  
è un'azienda dinamica che trae la sua  
essenza dal concept del "MADE IN ITALY"  
tramandato attraverso l'esperienza  
delle sue figure storiche che dal 1964  
si dedicano con entusiasmo alla  
progettazione e produzione di profili  
decorativi in alluminio e serrandine.  
Nella nostra sede di Settimo Milanese, che  
si sviluppa su una superficie complessiva  
di 5000 m<sup>2</sup>, creiamo prodotti sempre  
all'avanguardia e al passo con le più  
moderne tendenze del mondo del design  
per arredamento di interni a partire  
da materie prime di qualità eccellente.**

FBS Profilati srl, founded in 1999 by the second managerial generation in our family is a dynamic company deriving its essence from the concept of "MADE IN ITALY" handed down through the experience of senior figures who have enthusiastically committed to designing and manufacturing aluminium decorative profiles and tambour doors since 1964.

In our headquarters in Settimo Milanese, covering a total area of 5000m<sup>2</sup>, we create forefront and contemporary products up-to-date with modern furniture design trends using exclusively excellent raw materials.





# WINDLIGHT

Dall'esperienza FBS Profilati nella profilatura a freddo nasce la prima barra per strisce LED. Elegante sia a luce accesa che spenta: quando la fonte luminosa è accesa la luce si diffonde uniformemente attraverso lo schermo in alluminio microforato. Quando la luce è spenta lo schermo diventa un prezioso dettaglio.

Una famiglia di profili per LED unici e innovativi, declinati in vibranti finiture in grado di soddisfare qualsiasi esigenza di interior design.

*The first decorative LED profile was created relying on FBS Profilati's experience in roll forming. A stylish design: when the light is on the micro-perforated aluminium screen provides diffused light. When the light is off the aluminium screen becomes a precious detail.*

*An innovative and unique LED profile collection available in exciting finishes that will satisfy any interior design need.*



**materiali riciclabili**  
*recyclable materials*



**qualità**  
*quality*



**resistenza**  
*endurance*



**installazione rapida**  
*fast installation*

## **Profili da appoggio**

### *Surface mounted profiles*

---

**E1** pag. 6

**E1 WIND** pag. 8

## **Profili da incasso**

### *Recessed mounted profiles*

---

**R1** pag. 10

**R1 WIND** pag. 12

**M1** pag. 14

**M1 WIND** pag. 16

## **Specifiche tecniche**

### *Technical specifications*

---

pag. 17





## WINDLIGHT

# E1

Profilo da appoggio *Surface mounted profiles*

LUNGHEZZA BARRE <i>BARS LENGTH</i>	3000 mm
INGOMBRO PROFILO <i>PROFILE DIMENSIONS</i>	16,5 x 13 mm
FISSAGGIO <i>FIXING</i>	biadesivo / vite <i>self-adhesive / screw</i>

### LUMINOSO ED ECOSOSTENIBILE!

La prima barra per strisce led con schermo estetico in alluminio: quando la luce è spenta lo schermo in finitura metallica diventa un prezioso dettaglio.

Composta da tre elementi separati che semplificano al massimo l'installazione su misura del prodotto.

### **BRIGHT AND SUSTAINABLE!**

*The first bar for LED strips with an aesthetic aluminium screen: when the light is turned off the screen in metallic finish becomes a precious detail. Composed of three separate elements making the installation easy for everyone.*



## Diffusione luce *Light diffusion*

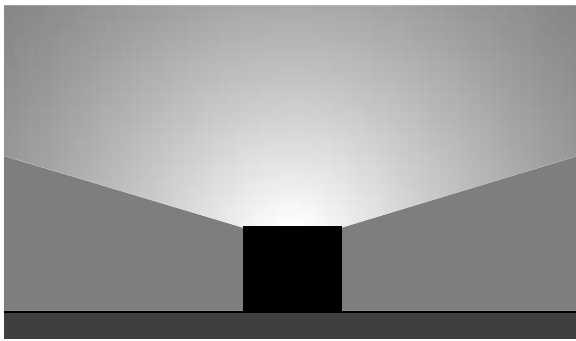

misure in mm - dimensions in mm

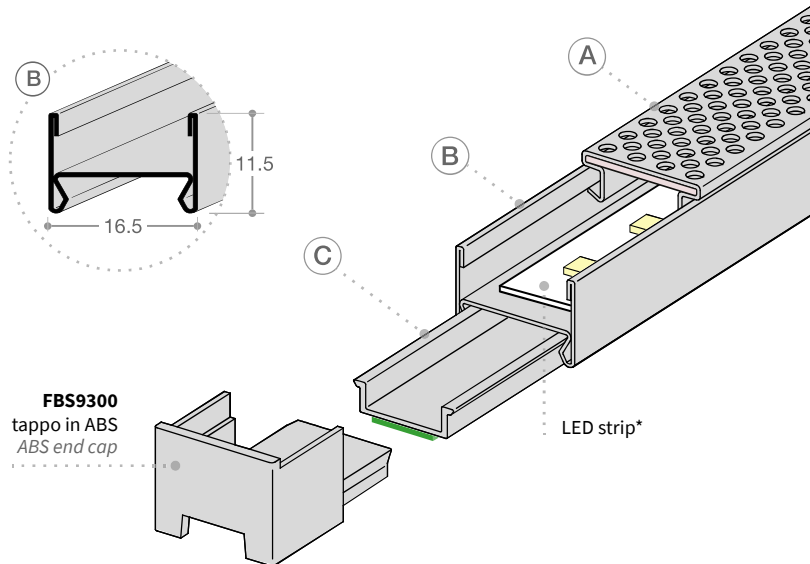
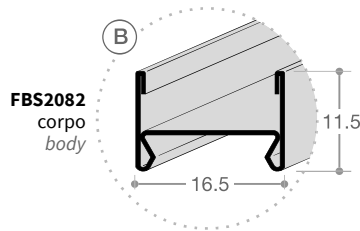
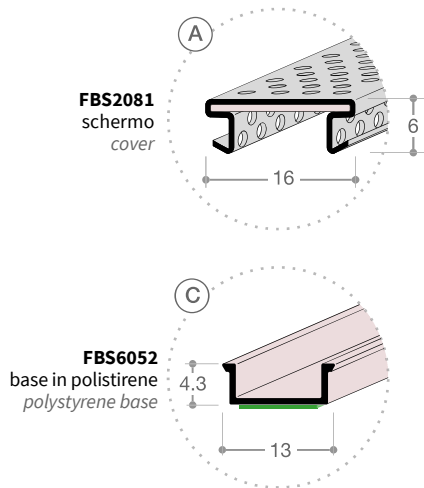

## Varianti *Options*

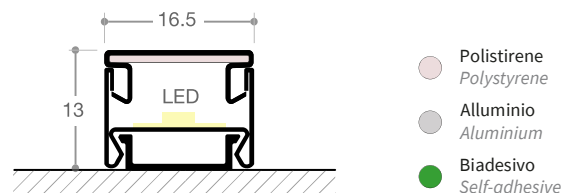
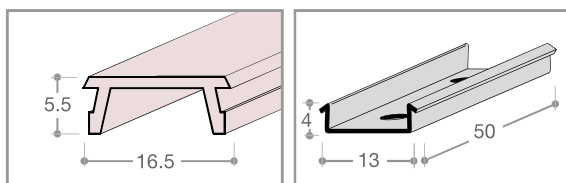

\* Striscia LED non fornita  
LED strip not supplied

## Finiture *Finishes*

ANODIZZATI ANODIZED

-  B3 - mill gold
-  RA - copper
-  D2 - gold
-  D - chrome
-  SN - sat nat
-  A2 - inox brushed

PREVERNICIATI PREPAINTED

-  L2 - matt black
-  U9 - anthracite
-  M4 - matt white





## WINDLIGHT **E1**WIND

Profilo da appoggio *Surface mounted profiles*

LUNGHEZZA BARRE <i>BARS LENGTH</i>	3000 mm
INGOMBRO PROFILO <i>PROFILE DIMENSIONS</i>	16,5 x 13 mm
FISSAGGIO <i>FIXING</i>	biadesivo / vite <i>adhesive / screw</i>

### LUCE IN 3D

In questa versione la micro foratura è estesa su tre lati. Come optional lo schermo in alluminio pieno permette di creare una diffusione della luce d'atmosfera e, quando spento, una decorazione preziosa.

### 3D LIGHT

*In this version the micro perforation is spread on all three sides. The optional full aluminium screen creates lateral mood light and, when turned off, becomes a precious decoration.*

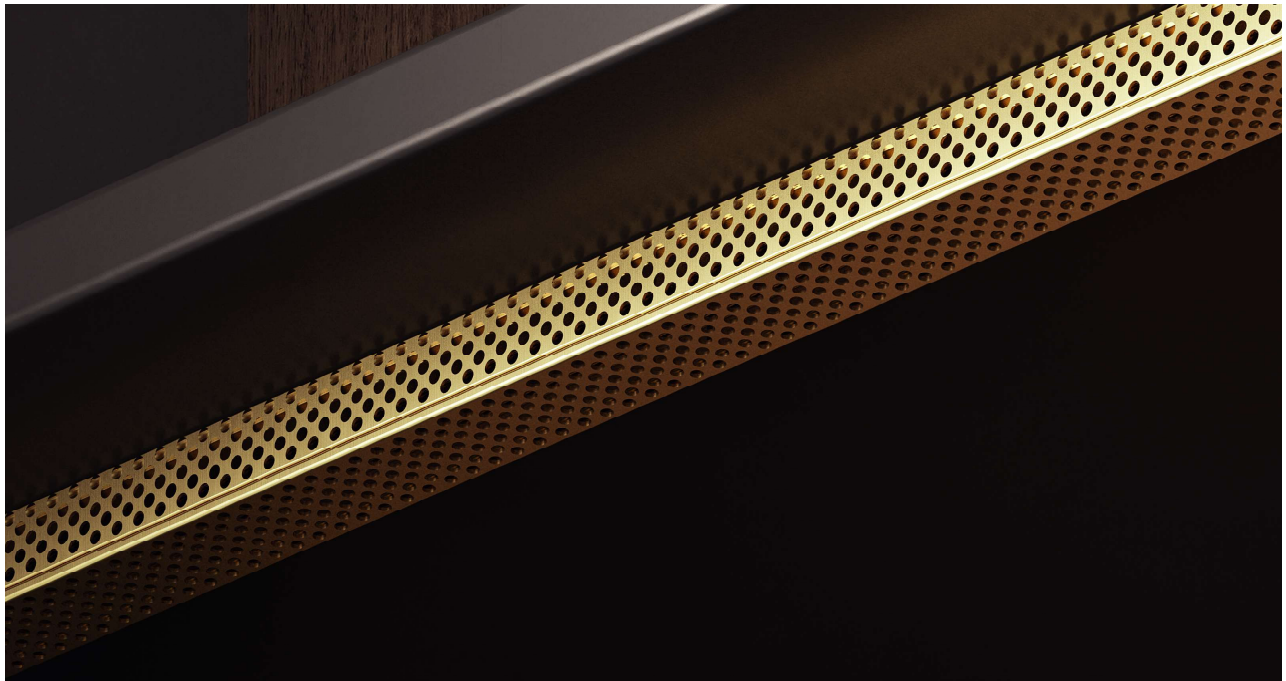

## Diffusione luce *Light diffusion*

FBS2081 wind / FBS6050

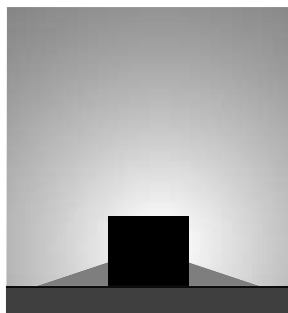

FBS2081 cieco blind

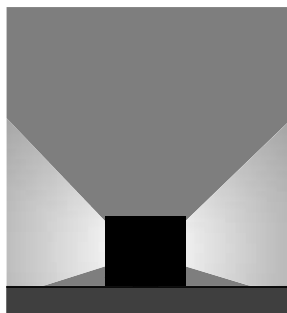

misure in mm - dimensions in mm

FBS2081  
schermo  
cover

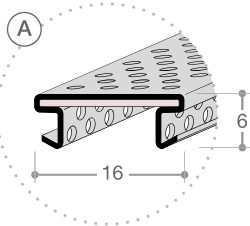

FBS2082 wind  
corpo  
body

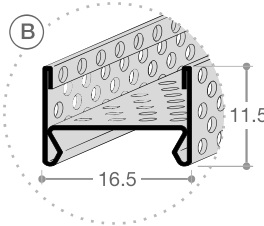

FBS6052  
base in polistirene  
polystyrene base

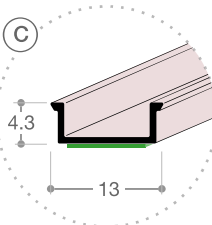

FBS9300  
tappo in ABS  
ABS end cap

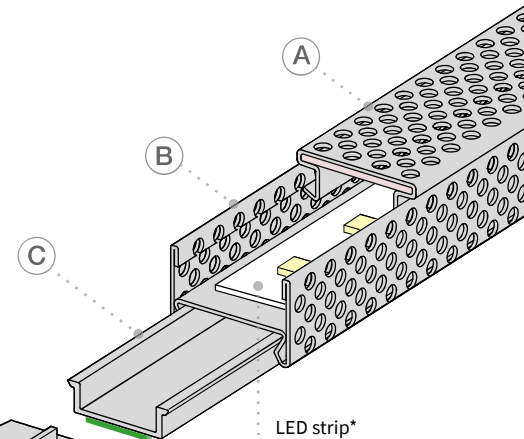
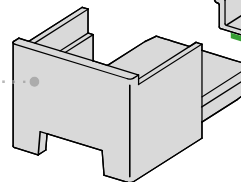

## ANODIZZATI ANODIZED

- B3 - mill gold
- RA - copper
- D2 - gold
- D - chrome
- SN - sat nat
- A2 - inox brushed

## PREVERNICIATI PREPAINTED

- L2 - matt black
- U9 - anthracite
- M4 - matt white

## Varianti *Options*

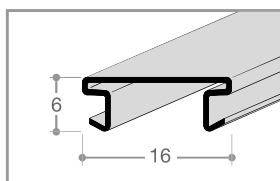

FBS2081 pieno  
schermo cieco  
blind cover

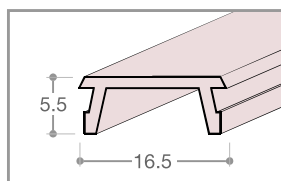

FBS6050  
schermo opalino  
opaline cover

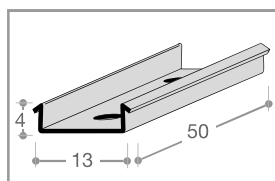

FBS2085  
profilo base in alluminio SN  
aluminium fixing profile SN

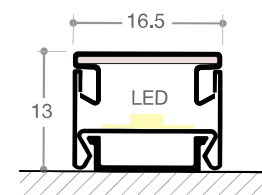

\* Striscia LED non fornita  
LED strip not supplied

- Polistirene  
Polystyrene
- Alluminio  
Aluminium
- Biadesivo  
Self-adhesive



## WINDLIGHT **R1**

Profilo da incasso *Recessed mounted profiles*

LUNGHEZZA BARRE <i>BARS LENGTH</i>	3000 mm
INGOMBRO PROFILO <i>PROFILE DIMENSIONS</i>	16,5 x 9 mm
FISSAGGIO <i>FIXING</i>	colla <i>glue</i>

### UN CLASSICO MODERNO

L'innovativo profilo in alluminio per strisce LED è realizzato con la nostra tecnologia di profilatura a freddo. Lo spessore ridotto e il pratico schermo coprifresata rendono il prodotto sia elegante che funzionale.

### A MODERN CLASSIC

*The innovative aluminium profile for LED strips is made with our roll forming technology. The reduced depth and the specific milling cover allow an elegant but still functional appearance.*





## Diffusione luce *Light diffusion*

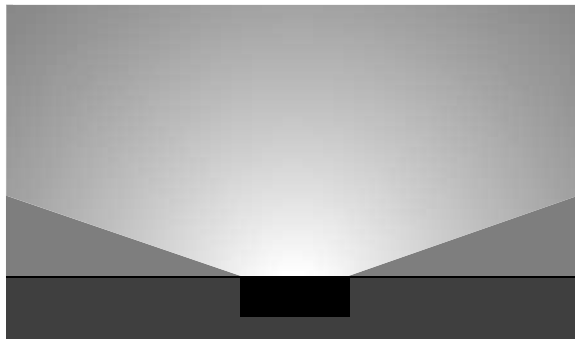

misure in mm - dimensions in mm

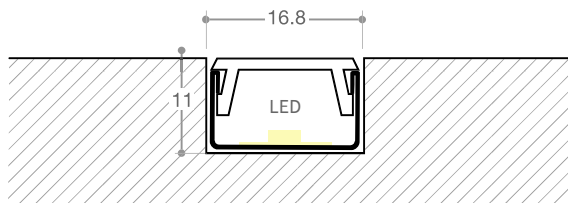
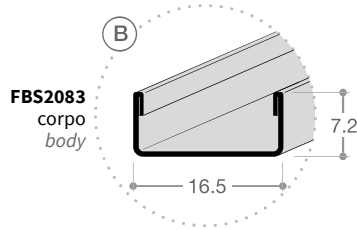
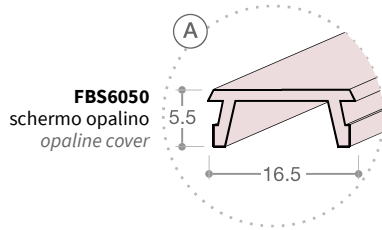

## Varianti *Options*

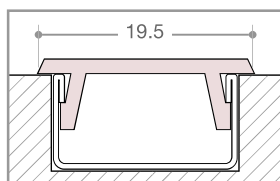

**FBS6051**  
schermo opalino coprifresata  
opaline milling cover

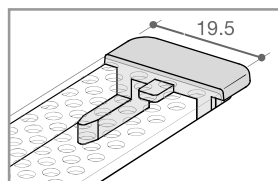

**FBS9301**  
tappo in nylon per FBS6051  
nylon end cap for FBS6051

## Finitura *Finish*

● **SN** - sat nat

Nota: FBS2083 solo in finitura **SN**  
Note: FBS2083 only available in **SN** finish

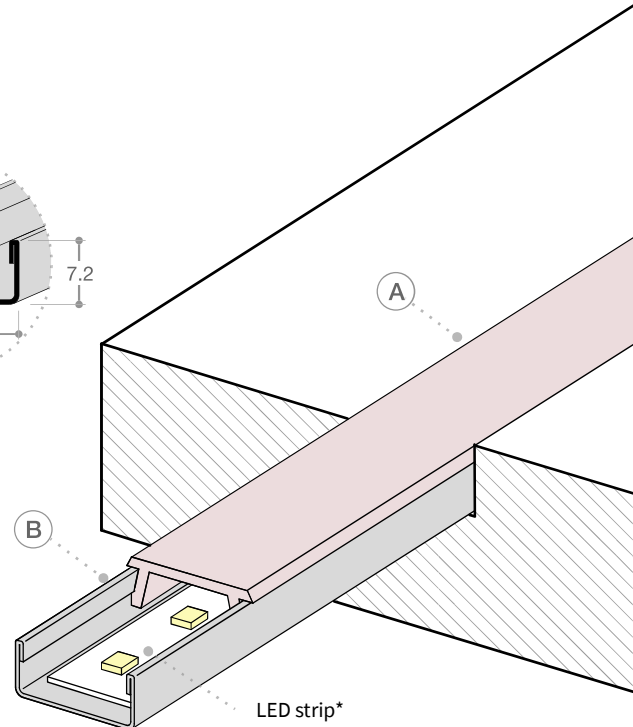

\* Striscia LED non fornita  
LED strip not supplied

● Polistirene  
Polystyrene  
● Alluminio  
Aluminium



## WINDLIGHT **R1**WIND

Profilo da incasso *Recessed mounted profiles*

LUNGHEZZA BARRE <i>BARS LENGTH</i>	3000 mm
INGOMBRO PROFILO <i>PROFILE DIMENSIONS</i>	16,5 x 9 mm
FISSAGGIO <i>FIXING</i>	colla <i>glue</i>

### GRANDE VARIETÀ DI FINITURE

Unendo forma e funzione gli schermi FBS micro-perforati, montati sul profilo ad incasso, sono un mix finemente lavorato di alluminio, colore e luce.

### WIDE RANGE OF FINISHES

*Fusing beauty and function FBS micro-perforated screen, mounted on the recessed profile, is a finely wrought cloud of aluminium, color and luminescence.*



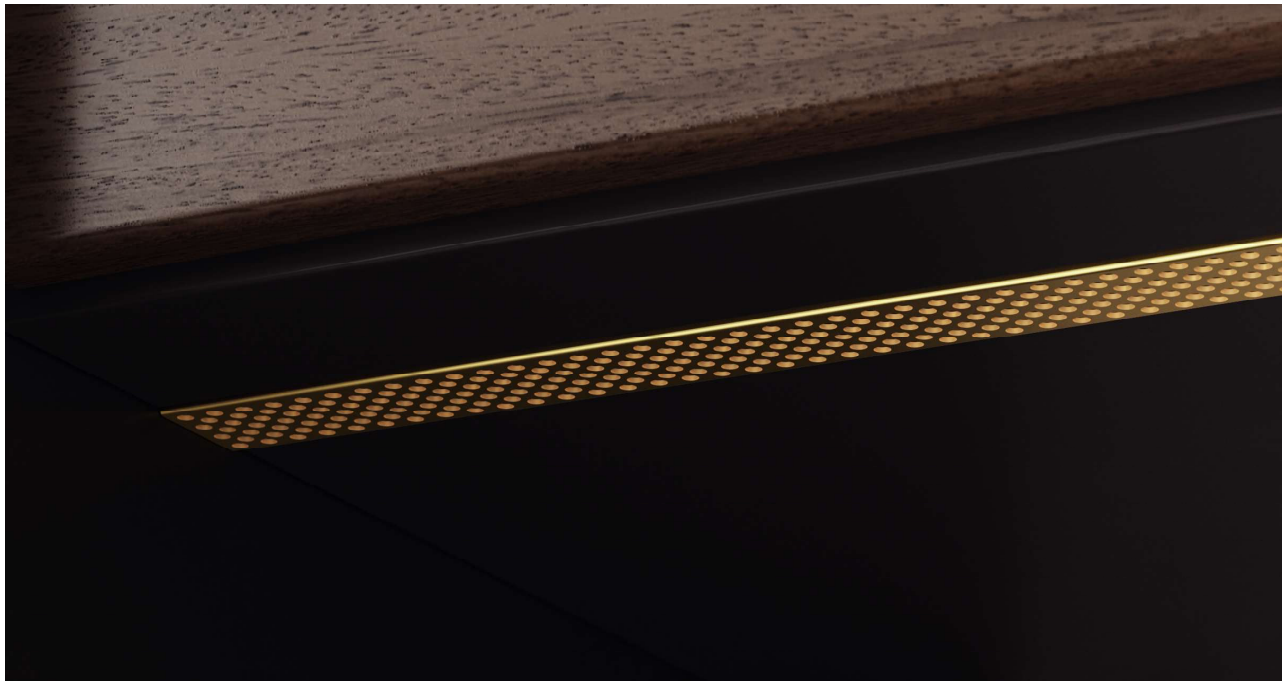

## Diffusione luce *Light diffusion*

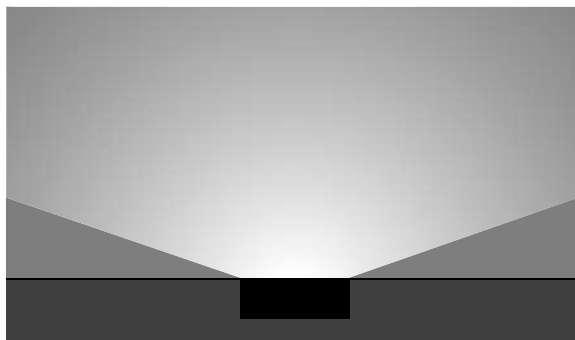

misure in mm - dimensions in mm

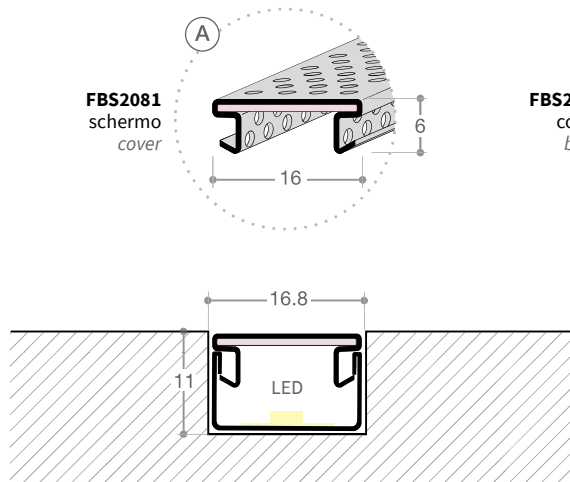

**FBS2081**  
schermo  
cover

**FBS2083**  
corpo  
body

## Varianti *Options*

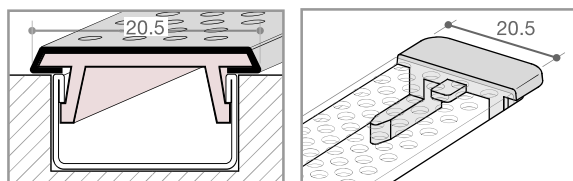

**FBS3050**  
schermo opalino + alluminio  
coprifresata  
opaline + aluminium milling cover

**FBS9307**  
tappo in nylon per FBS3050  
nylon end cap for FBS3050

## Finiture *Finishes*

ANODIZZATI ANODIZED

-  **B3** - mill gold
-  **RA** - copper
-  **D2** - gold
-  **D** - chrome
-  **SN** - sat nat
-  **A2** - inox brushed

PREVERNICIATI PREPAINTED

-  **L2** - matt black
-  **U9** - anthracite
-  **M4** - matt white

NOTA: FBS2083 SOLO  
IN FINITURA **SN**  
NOTE: FBS2083 ONLY AVAILABLE IN  
**SN** FINISHING

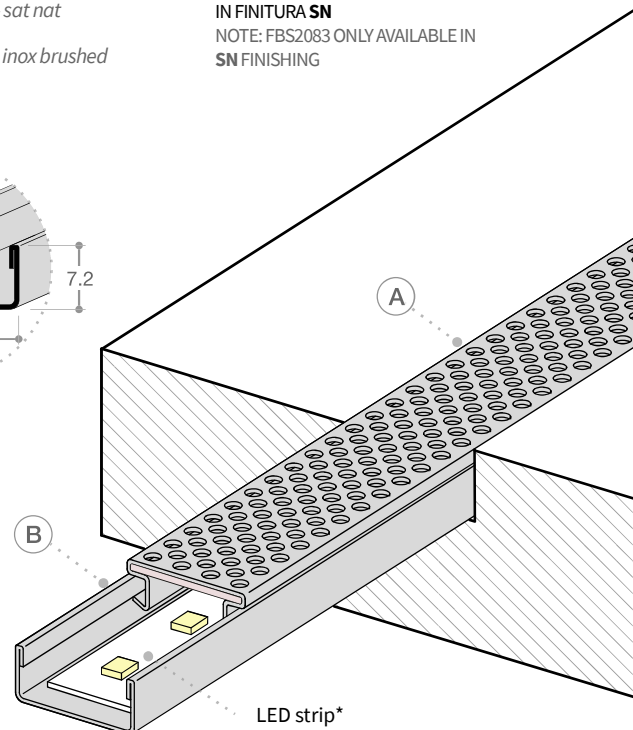

LED strip\*

\* Striscia LED non fornita  
LED strip not supplied

-  Polistirene  
Polystyrene
-  Alluminio  
Aluminium



## WINDLIGHT **M1**

Profilo da incasso *Recessed mounted profiles*

LUNGHEZZA BARRE <i>BAR LENGTH</i>	3000 mm
INGOMBRO PROFILO <i>PROFILE DIMENSIONS</i>	7,1 x 8,5 mm
FISSAGGIO <i>FIXING</i>	colla <i>glue</i>

### LO STRETTO NECESSARIO

Stesso design e fascino, in una forma più raffinata e minimalista. M1 diventa più piccolo ed elegante, pur mantenendo le stesse prestazioni dei profili più grandi.

### THE BARE MINIMUM

*Same design and allure, in a more refined and minimalist form. M1 gets smaller and sleeker, though it retains the very same performance as the bigger profiles.*



## Diffusione luce *Light diffusion*

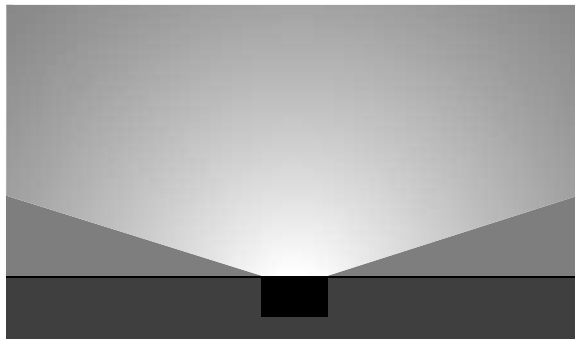

misure in mm - dimensions in mm

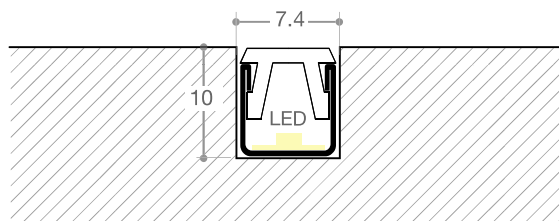
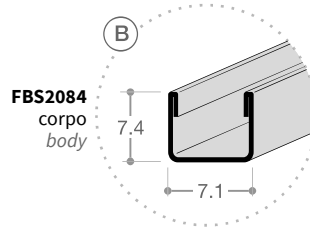
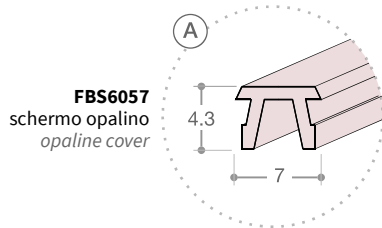

## Varianti *Options*

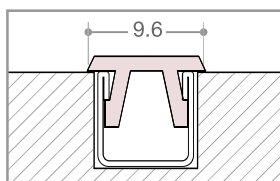

**FBS6056**  
schermo coprifresata  
milling cover

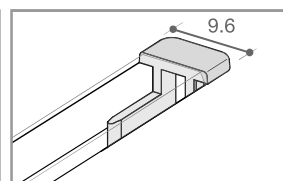

**FBS9303**  
tappo in nylon per FBS6056  
nylon end cap for FBS6056

## Finitura *Finish*

● **SN** - sat nat

Nota: FBS2084 solo in finitura **SN**  
Note: FBS2084 only available in **SN** finish

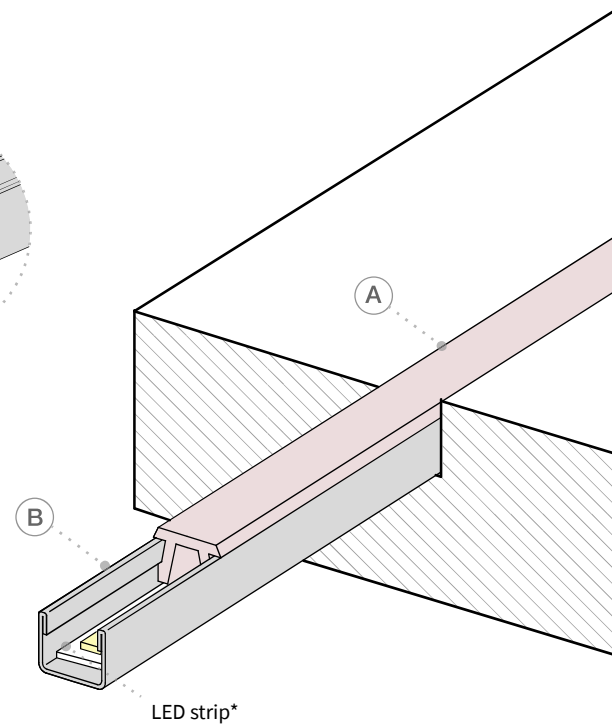

● Polistirene  
Polystyrene  
● Alluminio  
Aluminium

\* Striscia LED non fornita  
LED strip not supplied





## WINDLIGHT **M1**WIND

Profilo da incasso *Recessed mounted profiles*

LUNGHEZZA BARRE <i>BAR LENGTH</i>	3000 mm
INGOMBRO PROFILO <i>PROFILE DIMENSIONS</i>	7,1 x 8,5 mm
FISSAGGIO <i>FIXING</i>	biadesivo <i>self-adhesive</i>

### SCHERMO DECORATIVO IN ALLUMINIO

Un sorprendente profilo sottile e moderno. Disponibile ora con l'innovativo schermo FBS micro-perforato.

#### *DECORATIVE ALUMINIUM COVER*

*A strikingly slim and modern profile now available with the innovative FBS micro-perforated aluminium cover.*

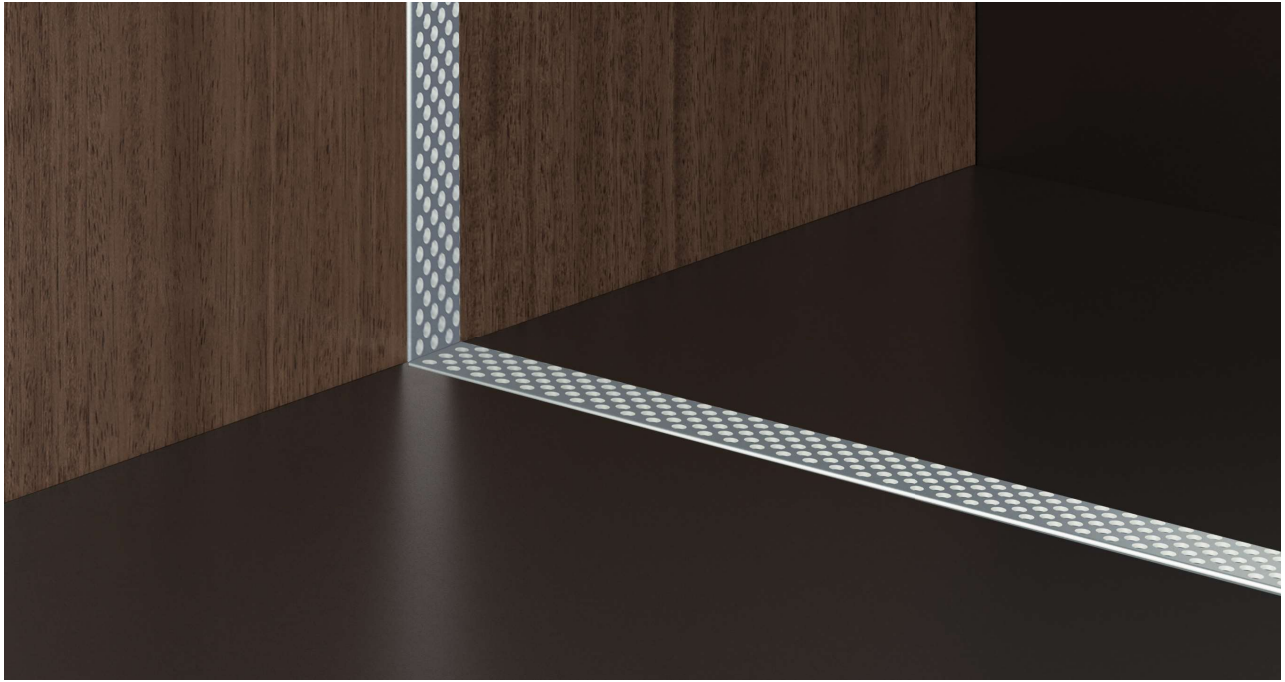

## Diffusione luce *Light diffusion*

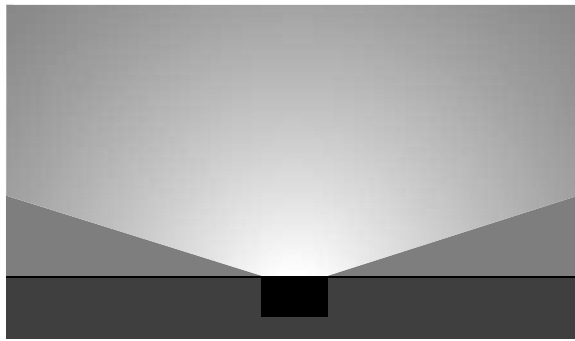

misure in mm - dimensions in mm

## Finiture *Finishes*

### ANODIZZATI *ANODIZED*

-  **B3** - mill gold
-  **RA** - copper
-  **D2** - gold
-  **D** - chrome
-  **SN** - sat nat
-  **A2** - inox brushed

### PREVERNICIATI *PREPAINTED*

-  **L2** - matt black
-  **U9** - anthracite
-  **M4** - matt white

NOTA: FBS2084 SOLO  
IN FINITURA SN

NOTE: FBS2084 ONLY AVAILABLE  
IN SN FINISHING

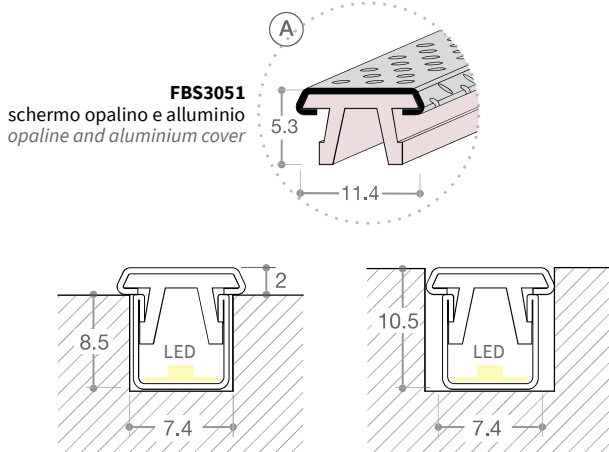

**FBS3051**  
schermo opalino e alluminio  
opaline and aluminium cover

**FBS2084**  
corpo  
body

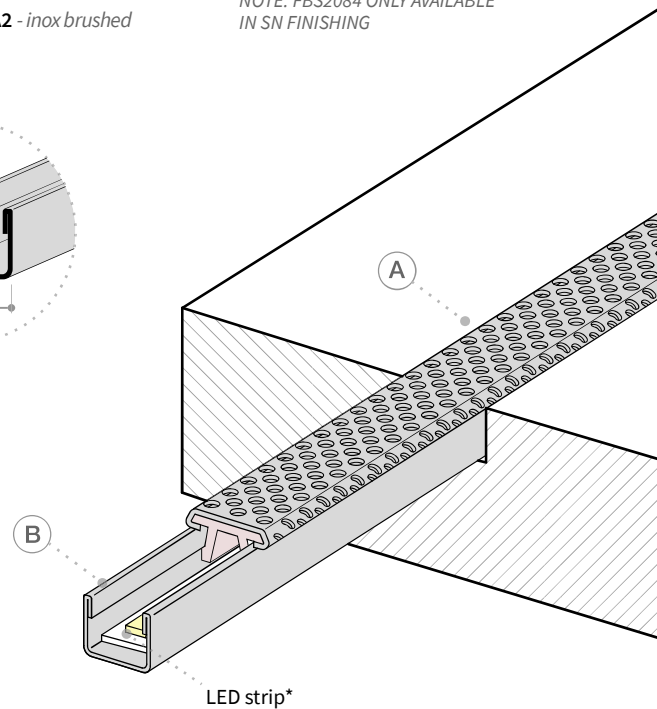

LED strip\*

## Varianti *Options*

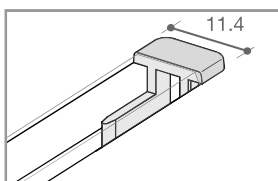

**FBS9308**  
tappo in nylon per FBS3051  
nylon end cap for FBS3051

\* Striscia LED non fornita  
LED strip not supplied

-  Polistirene  
Polystyrene
-  Alluminio  
Aluminium



# Istruzioni di montaggio *Mounting instructions* E1 - E1WIND

**IMPORTANTE!** Per un fissaggio ottimale del biadesivo assicurarsi che le superfici siano pulite con un detergente e completamente asciutte

*IMPORTANT!* For best results with the self-adhesive please make sure the surfaces are cleaned with a detergent and perfectly dry

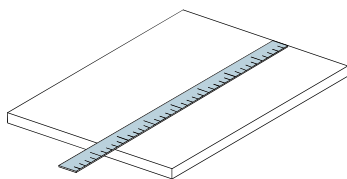

1. Misurare la lunghezza necessaria e tagliare a misura i profili seguendo le indicazioni sottoriportate *Take the measure of the required length and cut the profiles to size following the instructions below*

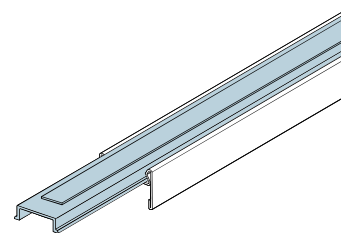

2. Inserire il profilo base nel profilo corpo *Insert the base profile into body profile*

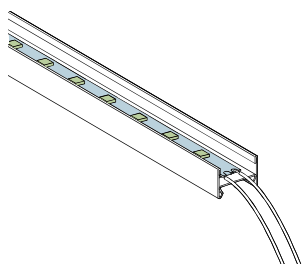

3. Tagliare a misura ed incollare la striscia LED sul profilo *Cut the LED strip to size and glue it onto the profile*

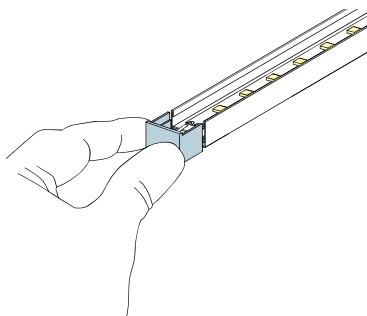

4. Inserire i tappi *Insert the end-caps*

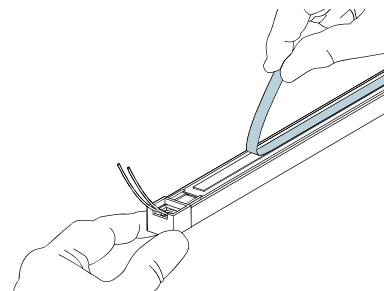

5. Rimuovere il film del biadesivo *Remove film from the self-adhesive strip*

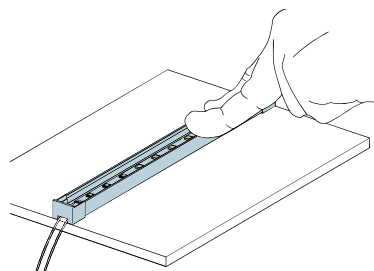

6. Incollare con una leggera pressione il profilo alla superficie *Stick the profile onto the surface applying a light pressure*

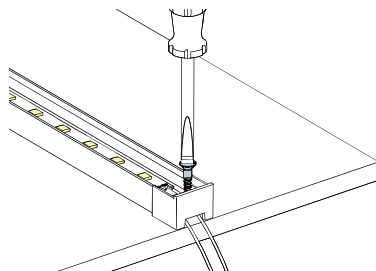

7. Se necessario fissare i tappi con delle viti *If necessary, fix the profile's end caps with screws*

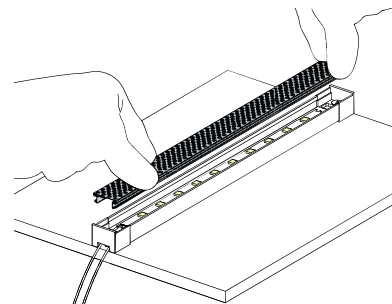

8. Fissare lo schermo a pressione *Clip the cover on*

## TAGLIO BARRE - MISURE PER VERSIONE CON TAPPI BARS CUTTING - DIMENSIONS FOR THE VERSION WITH END-CAPS

## FISSAGGIO A VITE - SOLO PER E1 E E1WIND SCREW FIXING - ONLY FOR E1 AND E1WIND

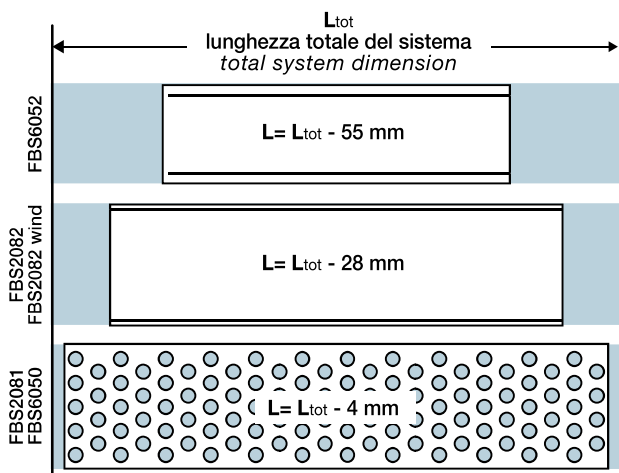

In alternativa all'adesivo è possibile fissare la barra LED tramite viti utilizzando il profilo FBS2080 in sostituzione al profilo FBS6052

*As an alternative to using self-adhesive there is the option of fixing the LED bar with screws by using profile FBS2080 instead of profile FBS6052*

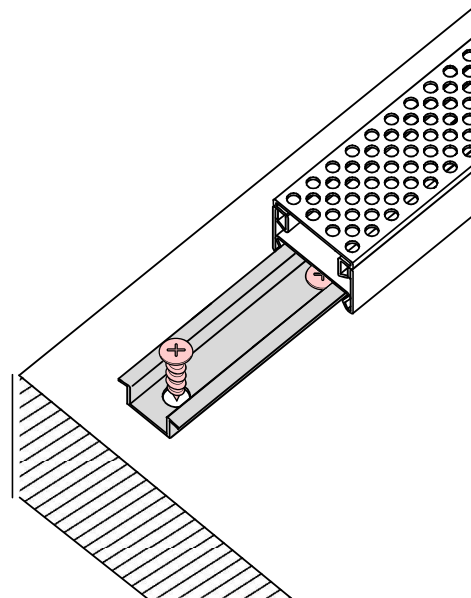
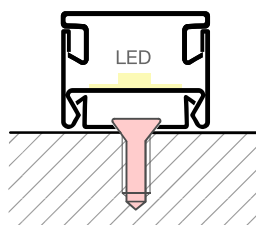

Per installazione con tappi FBS9300, i tre profili devono essere tagliati considerando le misure indicate

*For installation with FBS9300 end-caps the three profiles composing the system must be cut considering the dimensions diagram*

## Istruzioni di montaggio *Mounting instructions* R1 - M1

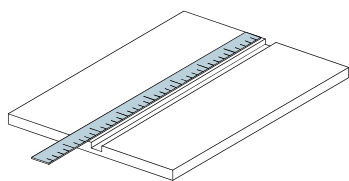

1. Misurare la lunghezza necessaria  
*Take the measure of the required length*

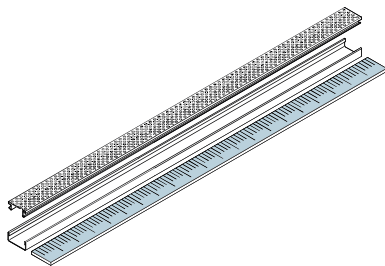

2. Tagliare a misura i profili  
*Cut the profiles to size*

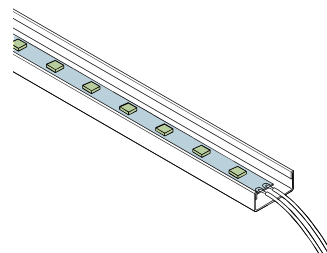

3. Tagliare a misura ed incollare la striscia LED sul profilo  
*Cut the LED strip to size and glue it onto the profile*

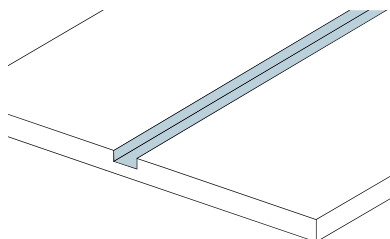

In caso di fresata continua, passare al punto 5  
*In case of continuous milling, go to n.5*

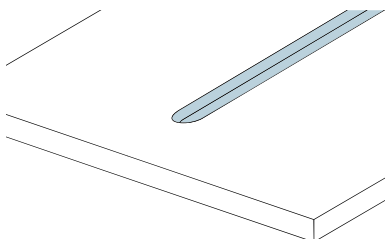

In caso di fresata interrotta sono necessari gli appositi tappi coprifresata  
*In case of interrupted milling the specific milling-cover endcaps are necessary*

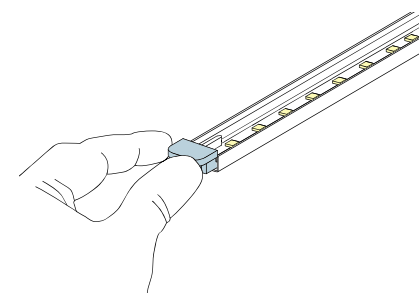

4. Inserire i tappi coprifresata  
*Insert the milling-cover end-caps*

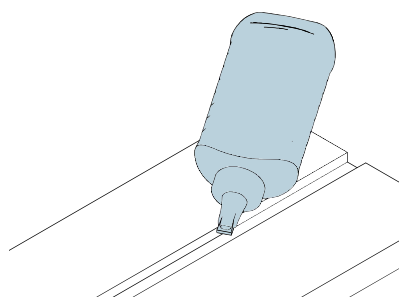

5. Applicare la colla nella fresata  
*Apply some glue into the milling channel*

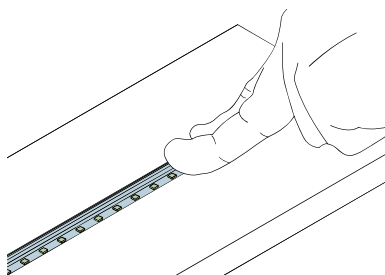

6. Incollare con una leggera pressione il profilo alla superficie  
*Stick the profile onto the surface applying a light pressure*

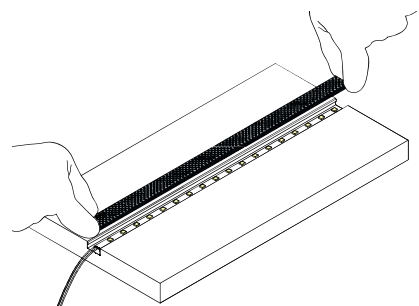

7. Fissare lo schermo a pressione  
*Clip the cover on*

## Specifiche *Technical details*

### ALLUMINIO PROFILATO A FREDDO

Windlight risponde a due importanti tendenze dell'interior design: materiali sostenibili e personalizzazione.

L'alluminio è profilato a freddo e quindi facilmente lavorabile con normali attrezzi da falegnameria.

I profili, forniti con pellicola protettiva, sono in barre standard di 3000 mm o tagliati su misura. Sono inoltre disponibili in nove finiture differenti.

### MICROFORATURA PER UN'ILLUMINAZIONE DI DESIGN

Questa originale lavorazione di micro-foratura dell'alluminio favorisce la dispersione del calore generato dal LED e arricchisce la finitura della superficie con contrasti di pieno e di vuoto.

### PERFORATION FOR A UNIQUE LIGHTING DESIGN

The innovative perforation process on the aluminium helps dissipating the heat generated by the LED and it greatly enhances the finishes for a stunning aesthetic result.

### VERSATILE AND MACHINING-FRIENDLY

Windlight is a technical and aesthetic answer to two interior design trends: sustainable materials and personalisation.

The roll-formed aluminium profiles can be machined with standard carpenters tools.

The profiles are supplied either in 3000 mm long bars or cut to size as per client specifications. They are available in nine different finishes with protective film.

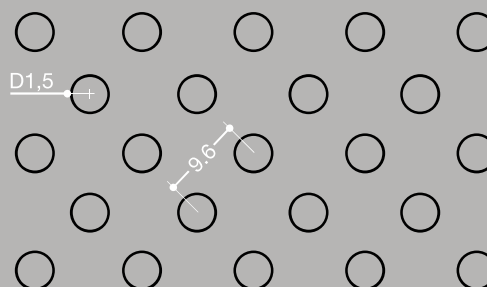



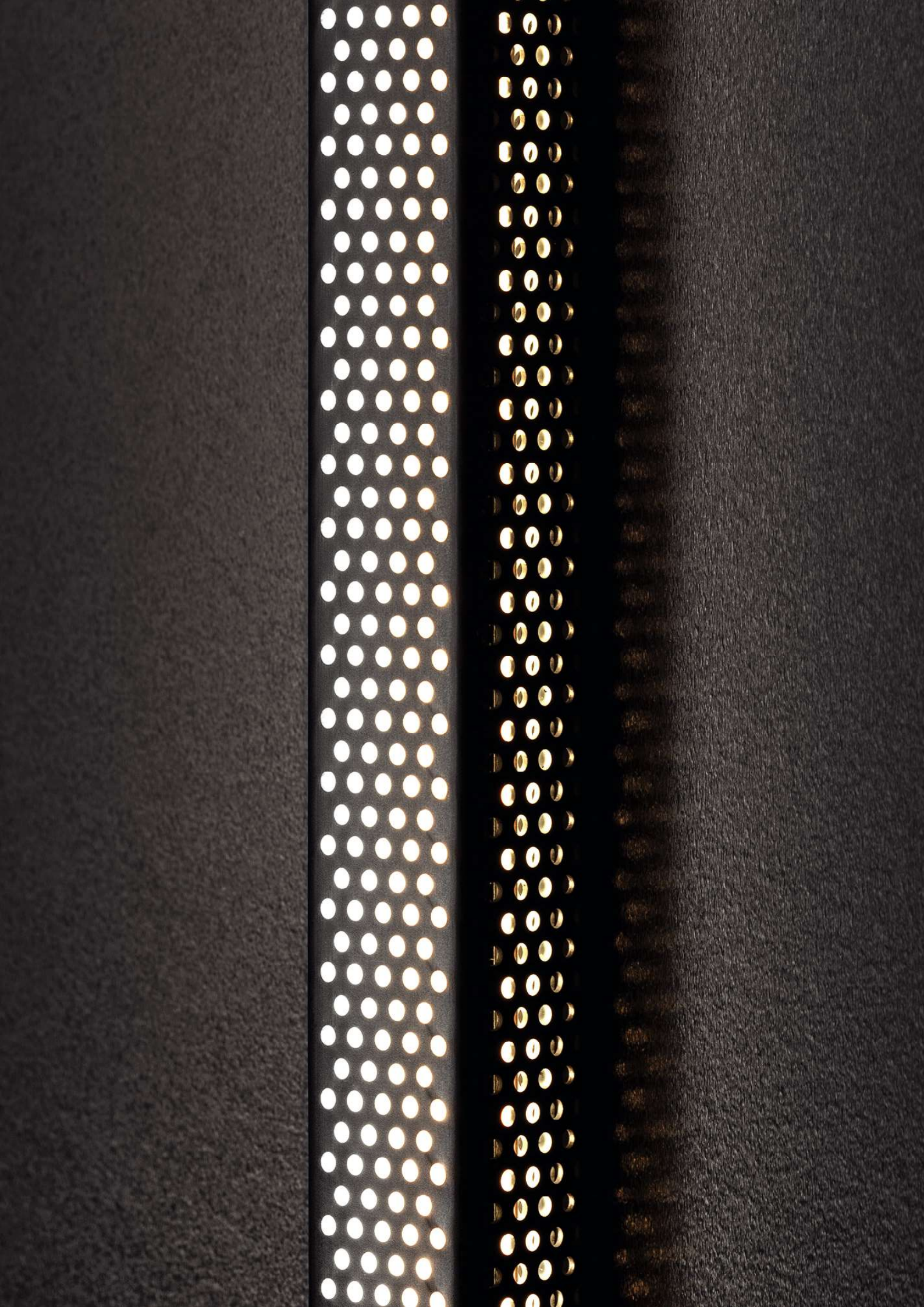



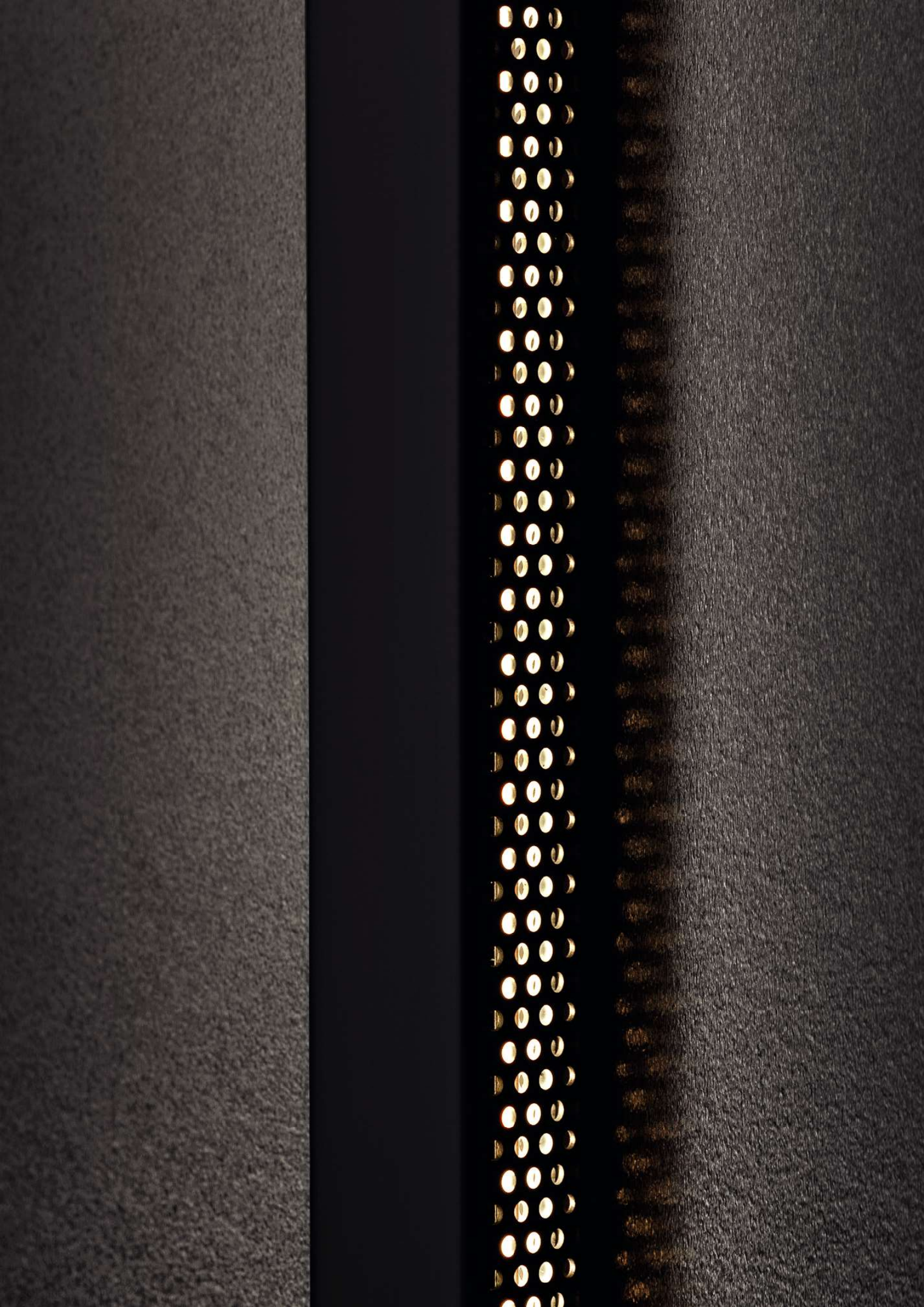

GUARDA LE ISTRUZIONI DI  
MONTAGGIO DI WINDLIGHT  
*WATCH THE WINDLIGHT  
INSTRUCTIONS VIDEO*

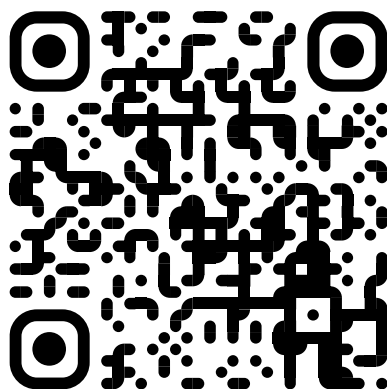

SCOPRI TUTTI I NOSTRI PRODOTTI SU  
*DISCOVER OUR FULL PRODUCT RANGE AT*

**fbsprofilati.it**



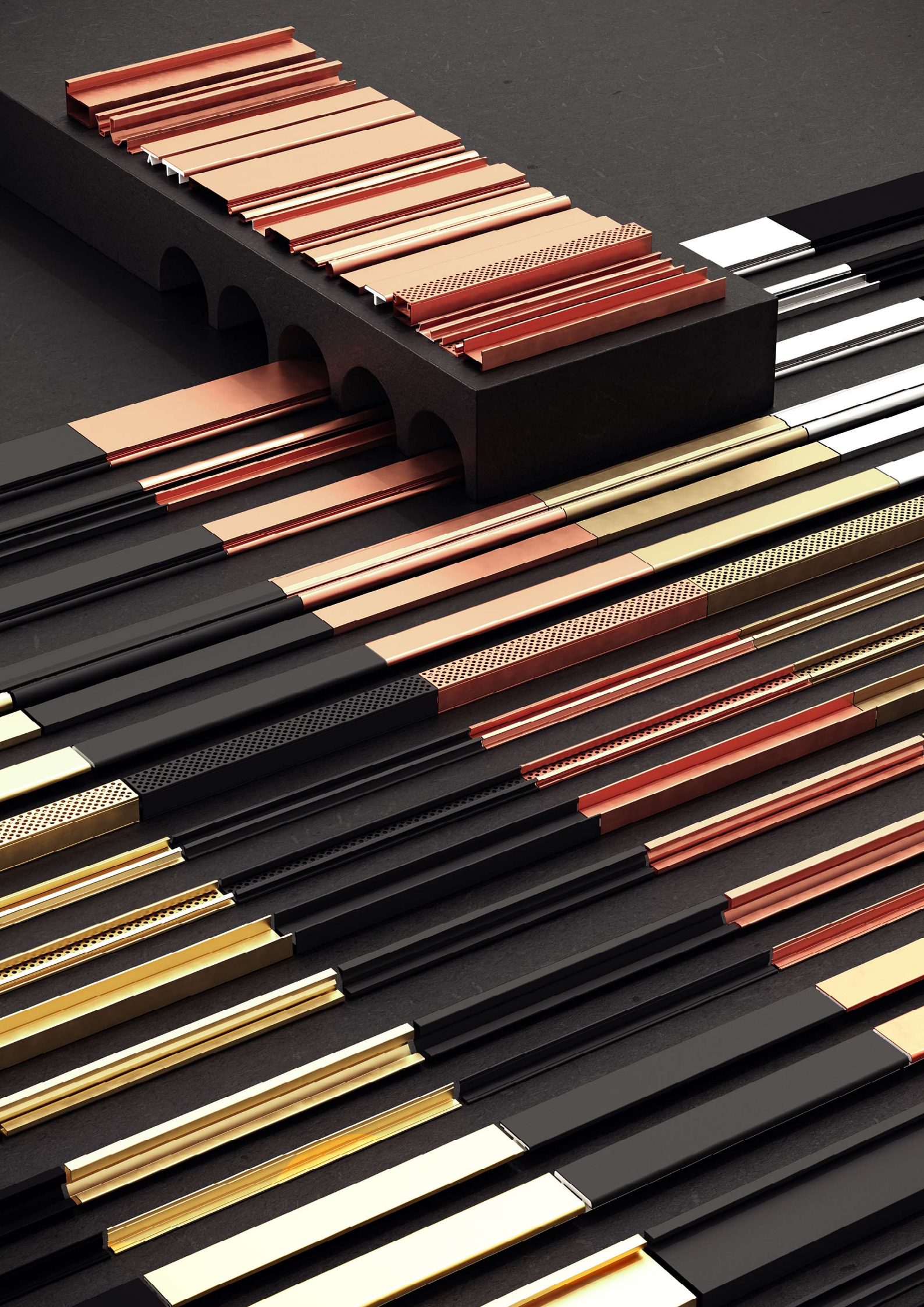

Il presente catalogo è di proprietà di FBSProfilati S.r.l.  
Tutti i diritti riservati.  
Sono vietate la riproduzione e alterazione.

Illustrazioni e dati contenuti in questo catalogo hanno  
valore indicativo. Per una corretta installazione fare  
riferimento ai manuali.

This catalogue is property of FBSProfilati S.r.l.  
All rights reserved.  
The reproduction and alteration are forbidden.

All illustrations and informations in this catalogue  
are indicative. For a correct installation please refer  
to the assembly instructions manuals.

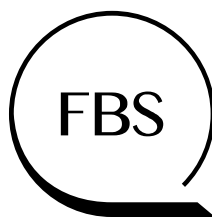

PROFILATI ITALIANI



**FBSProfilati srl**

**Via Edison, 251**  
20019 Settimo Milanese MI - Italia

phone: +39 024564768 | +39 0248916411

[info@fbprofilati.it](mailto:info@fbprofilati.it)

[fbprofilati.it](http://fbprofilati.it)