



# Motoroll



**materiali riciclabili**  
*recyclable materials*



**qualità**  
*quality*



**resistenza**  
*endurance*



**leggerezza**  
*lightness*



**installazione rapida**  
*fast installation*



**radiocomando**  
*remote control*

*Sistema di serrandine motorizzato 100% alluminio fornito in kit pre-assemblato, apertura con radiocomando. Disponibile in un ampio range di misure e accessori.*  
*Motorized 100% aluminium tambour door system supplied in pre-assembled kit, remote controlled opening. Available in a wide range of dimensions and accessories.*

MOTOROLL

# MR1 | Motoroll 9211

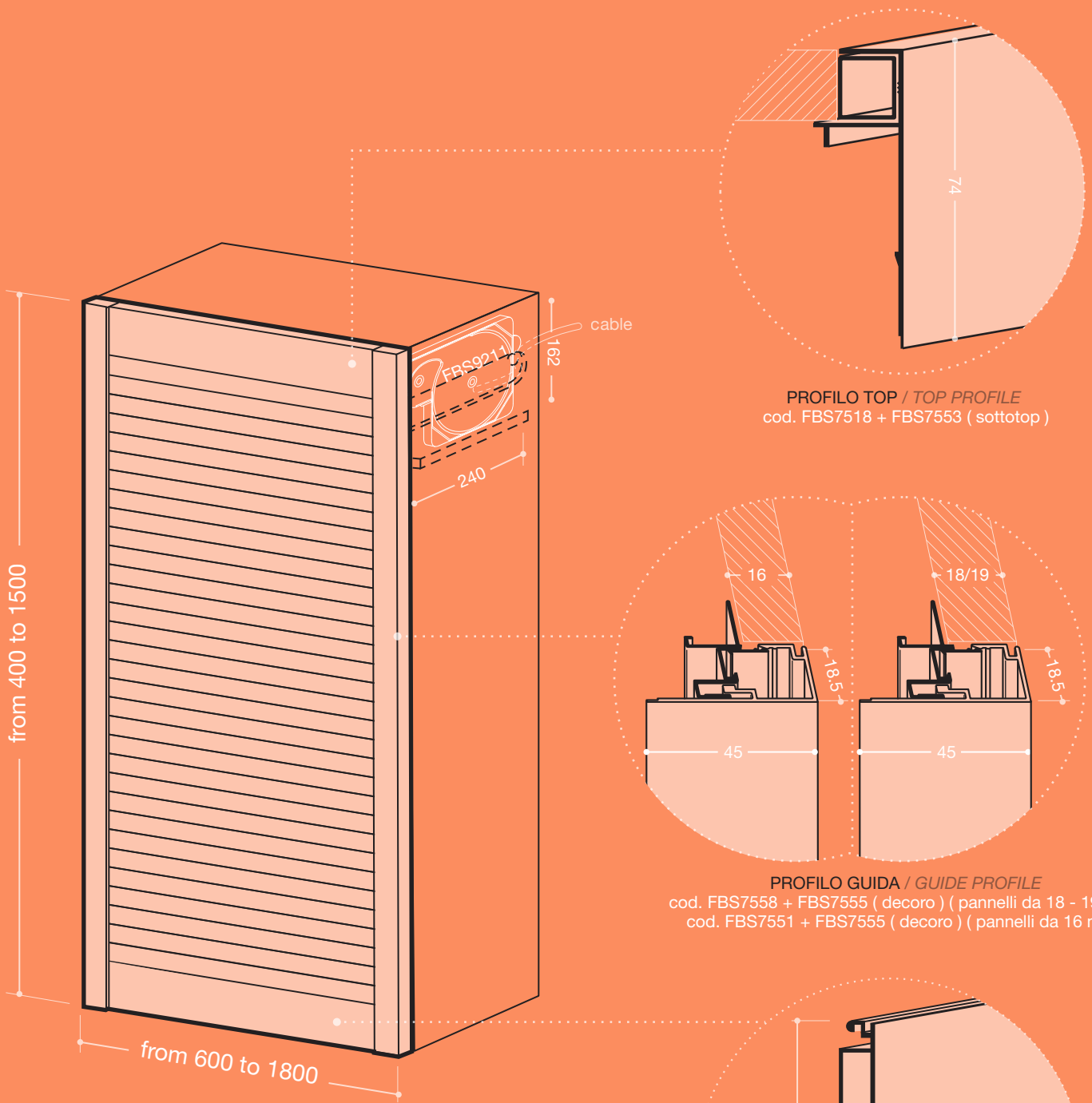

PROFILO TOP / TOP PROFILE  
cod. FBS7518 + FBS7553 ( sottotop )

PROFILO GUIDA / GUIDE PROFILE  
cod. FBS7558 + FBS7555 ( decoro ) ( pannelli da 18 - 19 mm )  
cod. FBS7551 + FBS7555 ( decoro ) ( pannelli da 16 mm )

PROFILO TERMINALE / BOTTOM PROFILE  
cod. FBS7512

misure in mm - dimensions in mm

SPESSORE PANNELLO BOARD THICKNESS	16 / 18 / 19 mm
INGOMBRO INTERNO PISTA INTERNAL COILER DIMENSIONS	240 x 162 mm
ARRETRAMENTO RIPIANI SHELVES SETBACK	50 mm

Compilare il presente modulo in tutte le sue parti per una corretta registrazione del vostro ordine.  
Fill in this sheet in full for a correct processing of your order

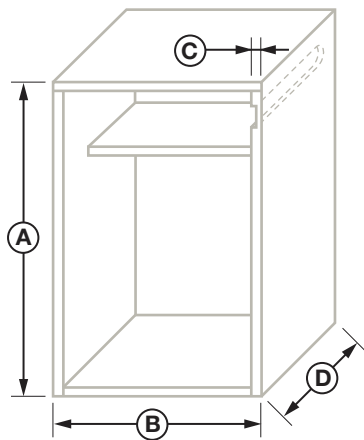

## Misure mobile / Cabinet dimensions

A	B	C	D	QUANTITÀ QUANTITY

## Varianti / Options

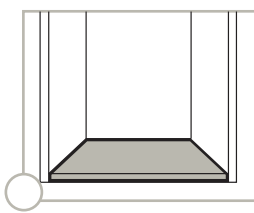

**box con base**  
box with basement

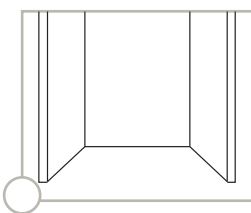

**box senza base**  
box without basement

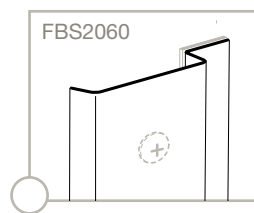

**profilo copriviti**  
screw cover profile

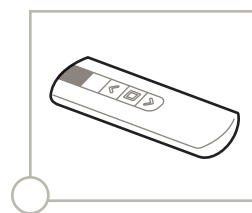

**radiocomando**  
remote control

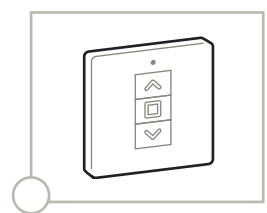

**radiocomando fisso**  
fixed remote control



**standard**

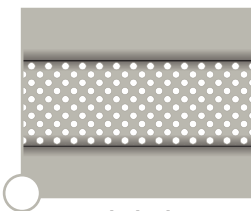

**wind mix**

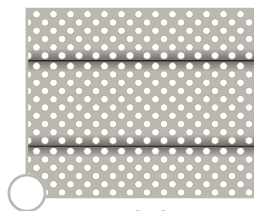

**wind**

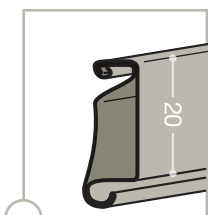

**FBS2000**  
rinforzato reinforced

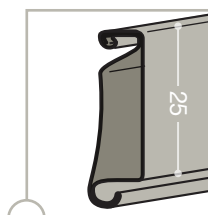

**FBS2025**  
rinforzato reinforced

## Finitura / Finishing

### ANODIZZATI / ANODIZED

- A - brushed
- A2 - inox brushed
- B - mill finish
- B2 - mill inox
- BR2 - matt bronze
- SN - sat nat

### PREVERNICIATI / PREPAINTED

- U5 - alumatt
- U6 - inox
- M3 - white
- M4 - matt white
- L2 - matt black
- MO01 - mahogany
- FR01 - ash
- NC01 - walnut

MOTOROLL

# MR2 | Motoroll 9227

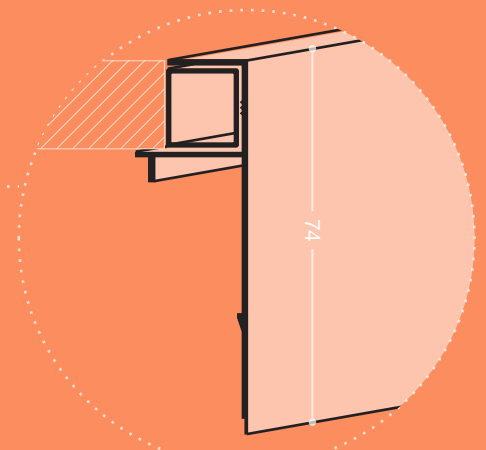
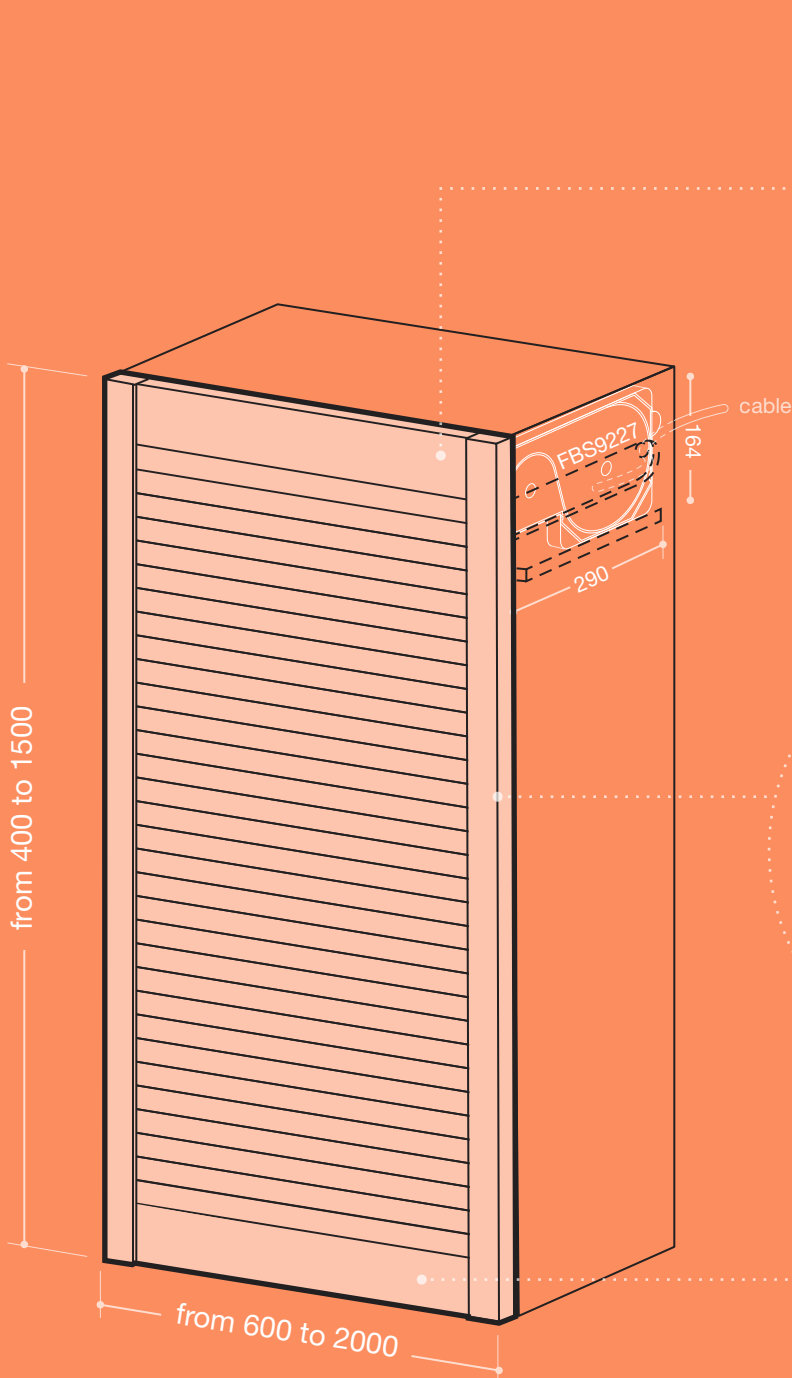

PROFILO TOP / TOP PROFILE  
cod. FBS7518 + FBS7553 ( sottotop )

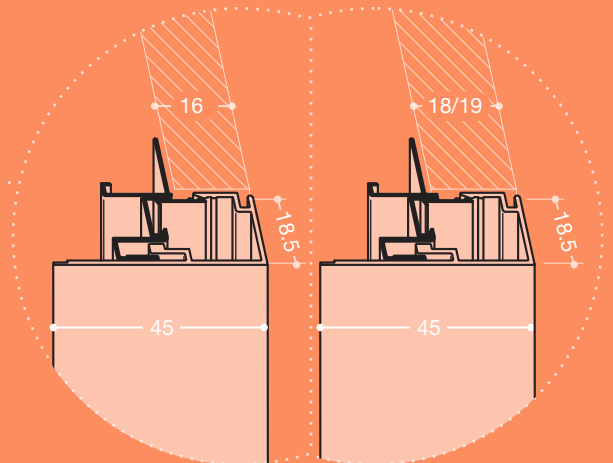

PROFILO GUIDA / GUIDE PROFILE  
cod. FBS7558 + FBS7555 ( decoro ) ( pannelli da 18 - 19 mm )  
cod. FBS7551 + FBS7555 ( decoro ) ( pannelli da 16 mm )

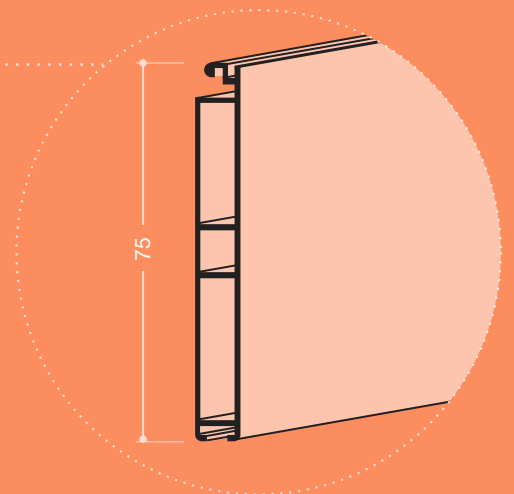

PROFILO TERMINALE / BOTTOM PROFILE  
cod. FBS7512

misure in mm - dimensions in mm

SPESSORE PANNELLO BOARD THICKNESS	16 / 18 / 19 mm
INGOMBRO INTERNO PISTA INTERNAL COILER DIMENSIONS	290 x 164 mm
ARRETRAMENTO RIPIANI SHELVES SETBACK	50 mm

# MR2 MODULO D' ORDINE / ORDER SHEET





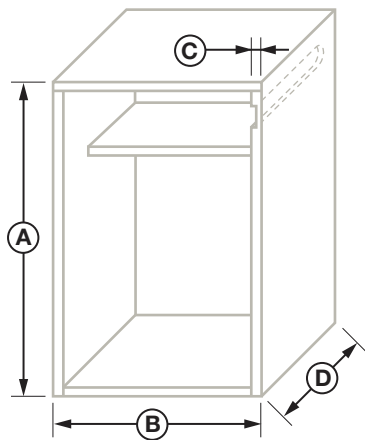

Compilare il presente modulo in tutte le sue parti per una corretta registrazione del vostro ordine.  
Fill in this sheet in full for a correct processing of your order

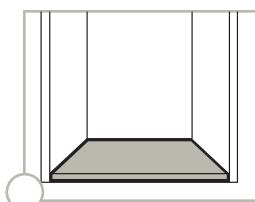
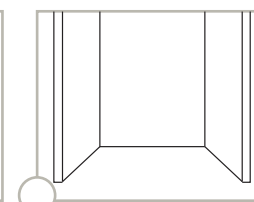
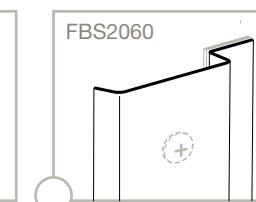
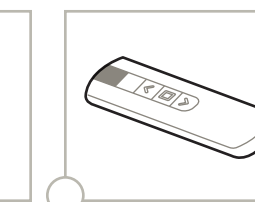
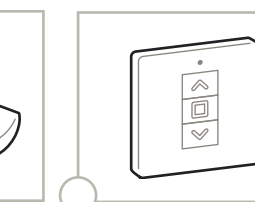

## Misure mobile / Cabinet dimensions

A	B	C	D	QUANTITÀ QUANTITY

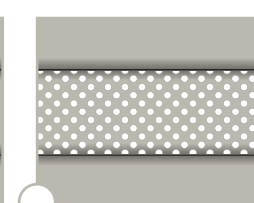
## Varianti / Options

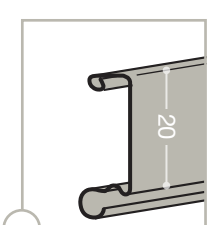
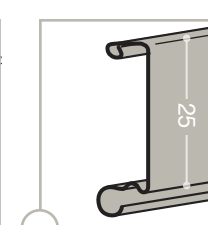
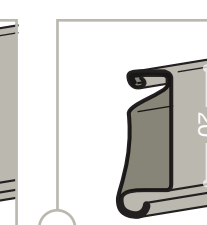
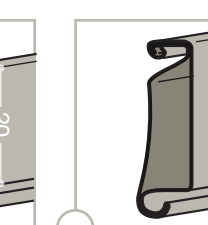
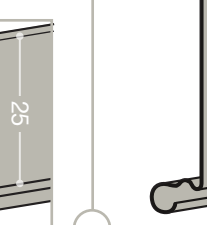
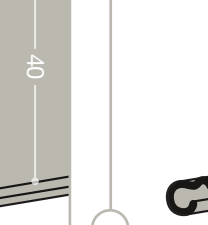
 <b>box con base</b> box with basement	 <b>box senza base</b> box without basement	 <b>FBS2060</b> profilo copriviti screw cover profile	 <b>radiocomando</b> remote control	 <b>radiocomando fisso</b> fixed remote control
 <b>standard</b>	 <b>wind mix</b>	 <b>wind</b>		
 <b>FBS2020</b>	 <b>FBS2125</b>	 <b>FBS2000</b> rinforzato reinforced	 <b>FBS2025</b> rinforzato reinforced	 <b>FBS2140</b>
				 <b>FBS2141</b> rinforzato reinforced

## Finitura / Finishing

### ANODIZZATI / ANODIZED

- A - brushed
- B2 - mill inox
- A2 - inox brushed
- BR2 - matt bronze
- B - mill finish
- SN - sat nat

### PREVERNICIATI / PREPAINTED

- U5 - alumatt
- M4 - matt white
- U6 - inox
- L2 - matt black
- M3 - white
- MO01 - mahogany
- FR01 - ash
- NC01 - walnut

Alcune varianti di dogia non sono disponibili in tutte le finiture Some type of slat are not available in all the finishing

MOTOROLL

# MR3 | Motoroll 9226

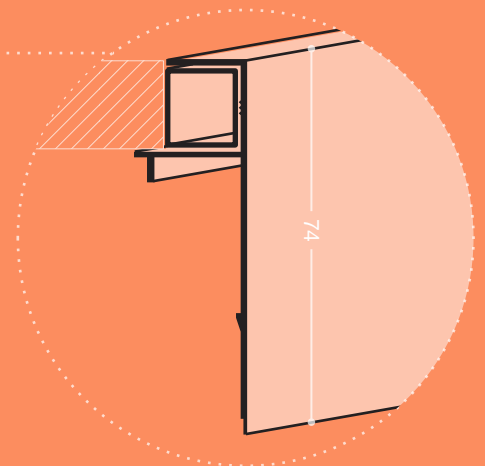
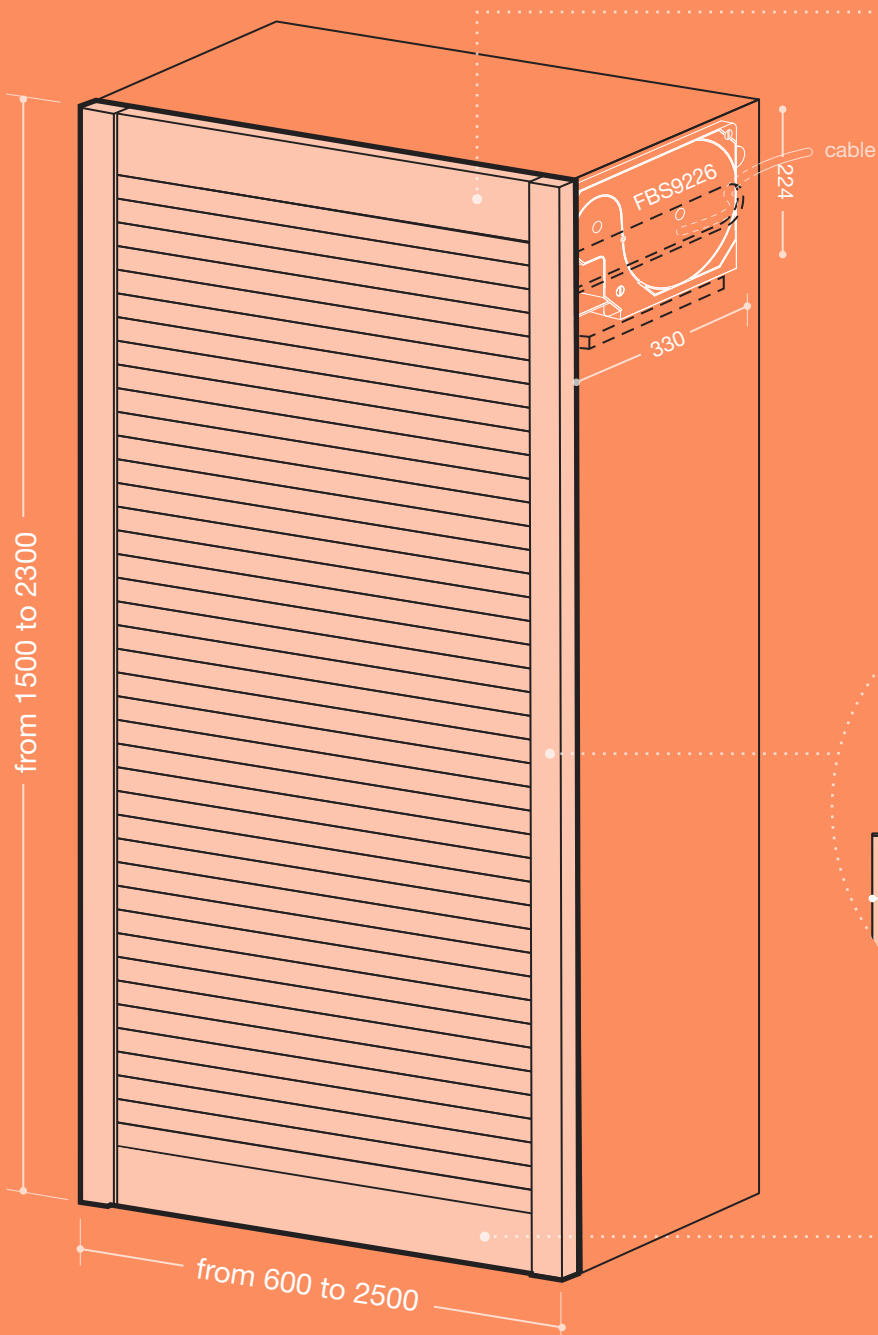

PROFILO TOP / TOP PROFILE  
cod. FBS7518 + FBS7553 ( sottotop )

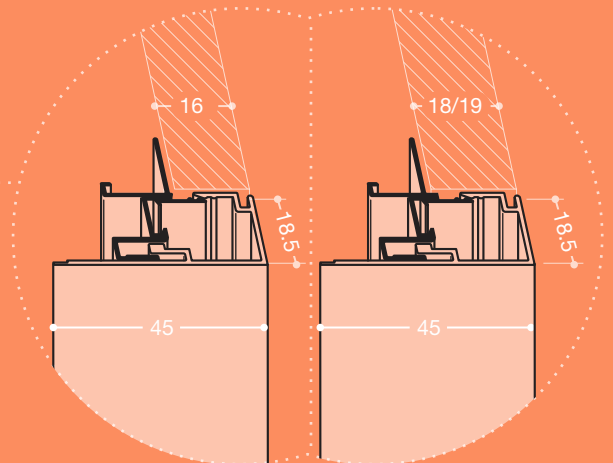

PROFILO GUIDA / GUIDE PROFILE  
cod. FBS7558 + FBS7555 ( decoro ) ( pannelli da 18 - 19 mm )  
cod. FBS7551 + FBS7555 ( decoro ) ( pannelli da 16 mm )

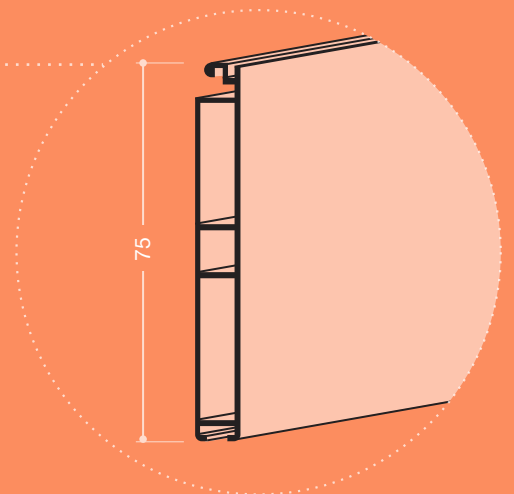

PROFILO TERMINALE / BOTTOM PROFILE  
cod. FBS7512

misure in mm - dimensions in mm

SPESSORE PANNELLO BOARD THICKNESS	16 / 18 / 19 mm
INGOMBRO INTERNO PISTA INTERNAL COILER DIMENSIONS	330 x 224 mm
ARRETRAMENTO RIPIANI SHELVES SETBACK	50 mm
MASSIMA SUPERFICIE H x L maximum surface H x W	4 m <sup>2</sup>

# MR3 MODULO D' ORDINE / ORDER SHEET





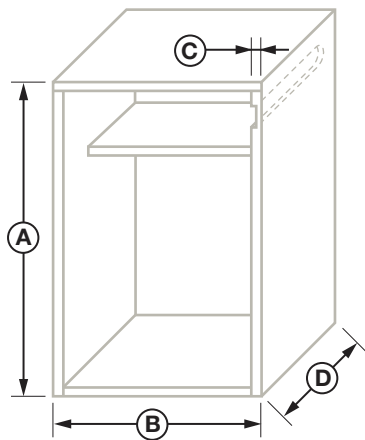

Compilare il presente modulo in tutte le sue parti per una corretta registrazione del vostro ordine.  
Fill in this sheet in full for a correct processing of your order

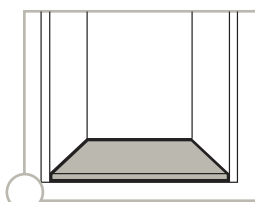
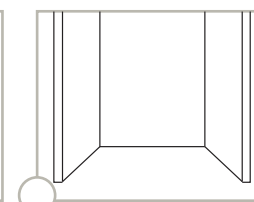
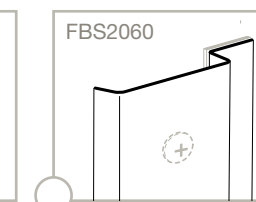
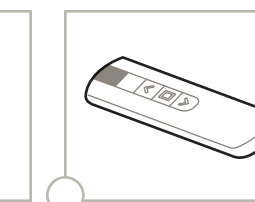
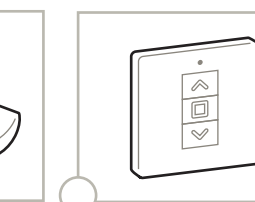

## Misure mobile / Cabinet dimensions

A	B	C	D	QUANTITÀ QUANTITY

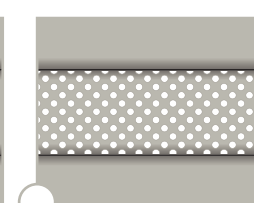
## Varianti / Options

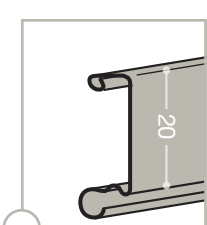
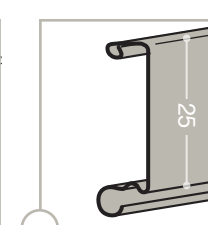
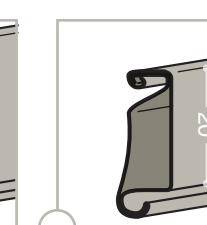
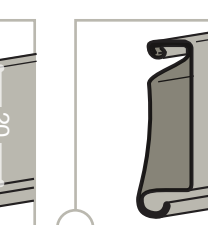
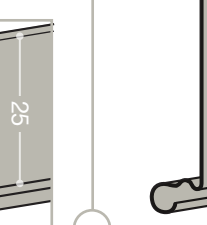
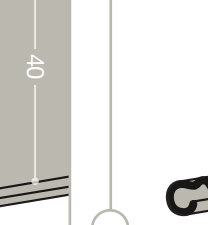
 <b>box con base</b> box with basement	 <b>box senza base</b> box without basement	 <b>FBS2060</b> profilo copriviti screw cover profile	 <b>radiocomando</b> remote control	 <b>radiocomando fisso</b> fixed remote control
 <b>standard</b>	 <b>wind mix</b>	 <b>wind</b>		
 <b>FBS2020</b>	 <b>FBS2125</b>	 <b>FBS2000</b> rinforzato reinforced	 <b>FBS2025</b> rinforzato reinforced	 <b>FBS2140</b>
				 <b>FBS2141</b> rinforzato reinforced

## Finitura / Finishing

### ANODIZZATI / ANODIZED

- A - brushed
- B2 - mill inox
- A2 - inox brushed
- BR2 - matt bronze
- B - mill finish
- SN - sat nat

### PREVERNICIATI / PREPAINTED

- U5 - alumatt
- M4 - matt white
- U6 - inox
- L2 - matt black
- M3 - white
- MO01 - mahogany
- FR01 - ash
- NC01 - walnut

Alcune varianti di dogia non sono disponibili in tutte le finiture Some type of slat are not available in all the finishing



MOTOROLL

# MR4 | Motoroll 9226 Minimal

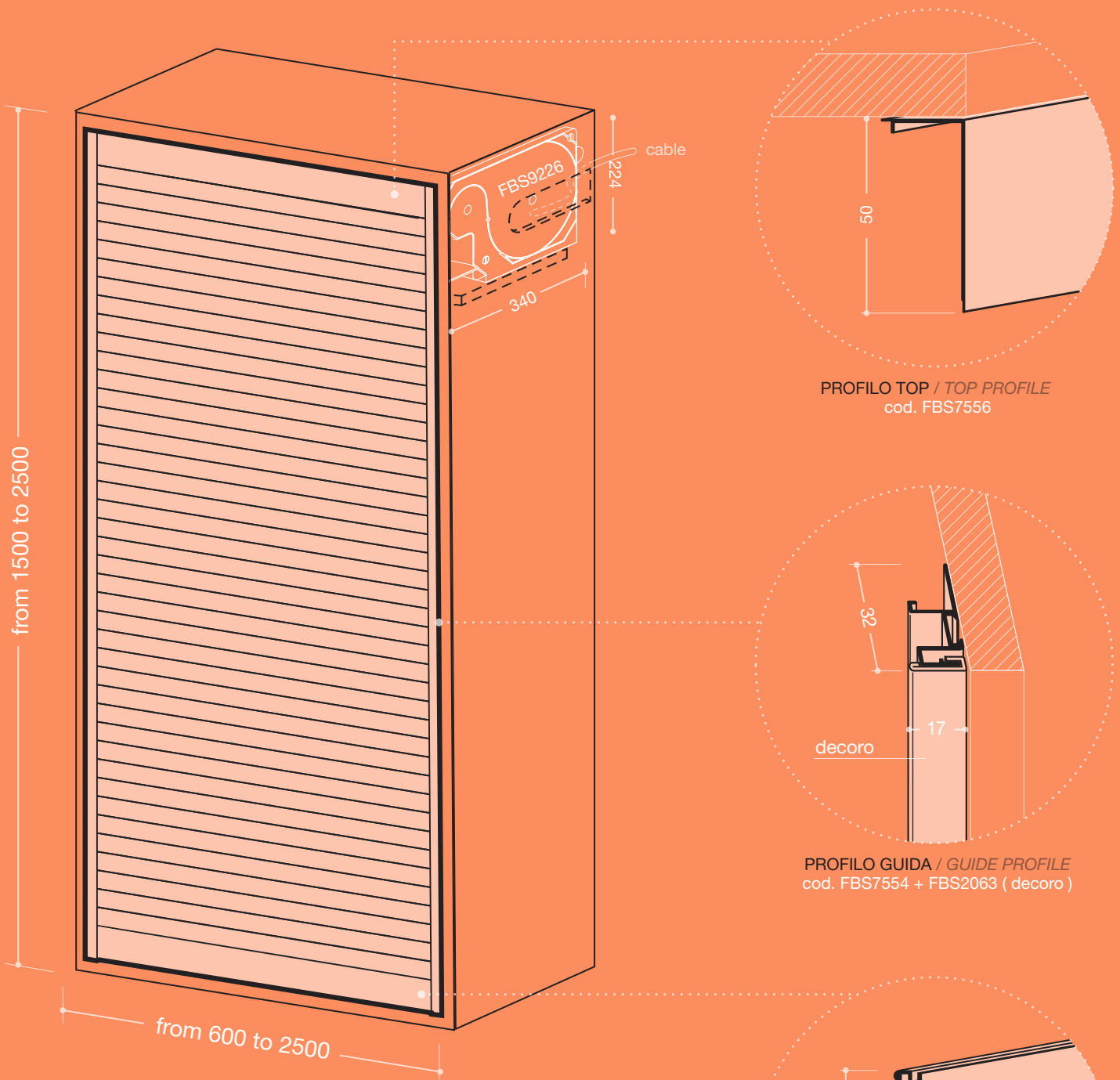

misure in mm - dimensions in mm

SPESSORE PANNELLO BOARD THICKNESS	qualsiasi / any
INGOMBRO INTERNO PISTA INTERNAL COILER DIMENSIONS	340 x 224 mm
ARRETRAMENTO RIPIANI SHELVES SETBACK	50 mm
MASSIMA SUPERFICIE H x L maximum surface H x W	4 m <sup>2</sup>

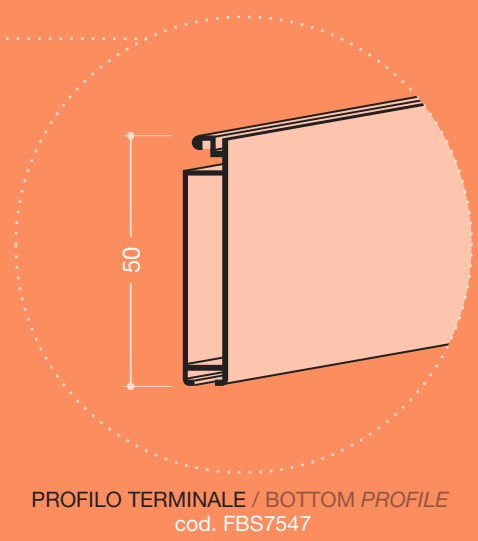



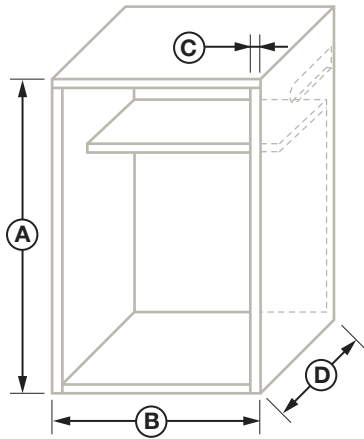

Compilare il presente modulo in tutte le sue parti per una corretta registrazione del vostro ordine.  
Fill in this sheet in full for a correct processing of your order

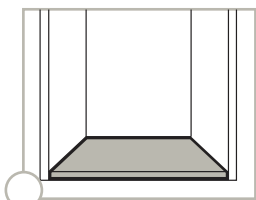
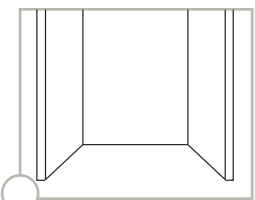
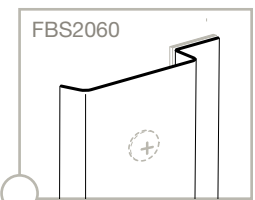
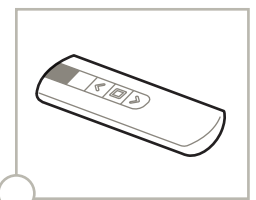
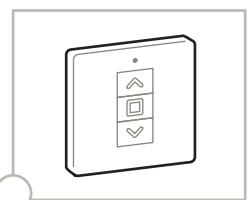

## Misure mobile / Cabinet dimensions

A	B	C	D	QUANTITÀ QUANTITY

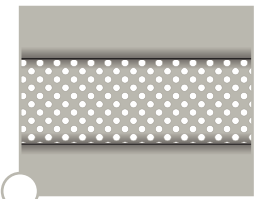
## Varianti / Options

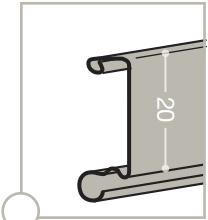
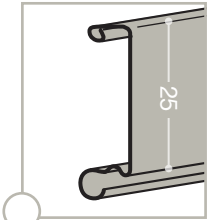
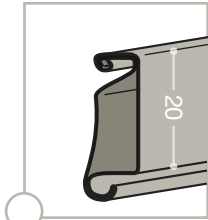
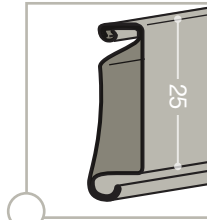
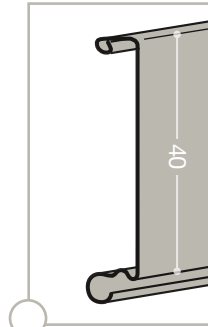
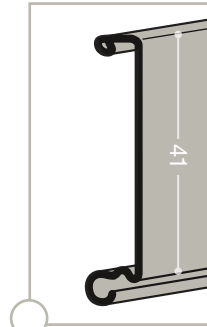
 <b>box con base</b> box with basement	 <b>box senza base</b> box without basement	 <b>FBS2060</b> profilo copriviti screw cover profile	 <b>radiocomando</b> remote control	 <b>radiocomando fisso</b> fixed remote control
 <b>standard</b>	 <b>wind mix</b>	 <b>wind</b>		
 <b>FBS2020</b>	 <b>FBS2125</b>	 <b>FBS2000</b> rinforzato reinforced	 <b>FBS2025</b> rinforzato reinforced	 <b>FBS2140</b>
				 <b>FBS2141</b> rinforzato reinforced

## Finitura / Finishing

### ANODIZZATI / ANODIZED

- A - brushed
- A2 - inox brushed
- B - mill finish
- B2 - mill inox
- BR2 - matt bronze
- SN - sat nat

### PREVERNICIATI / PREPAINTED

- U5 - alumatt
- U6 - inox
- M3 - white
- M4 - matt white
- L2 - matt black
- MO01 - mahogany
- FR01 - ash
- NC01 - walnut

Alcune varianti di dogia non sono disponibili in tutte le finiture Some type of slat are not available in all the finishing